

STENNER PUMPS®

PERISTALTIC METERING PUMPS SINCE 1957



FARMER BOY®

ECON INTEGRATOR™
PERISTALTIC METERING PUMP

.....
INSTALLATION AND MAINTENANCE MANUAL

 **WARNING**

TO BE INSTALLED AND MAINTAINED BY PROPERLY TRAINED
PROFESSIONAL INSTALLER ONLY. READ MANUAL & LABELS
FOR ALL SAFETY INFORMATION & INSTRUCTIONS.

TABLE OF CONTENTS

| | |
|---|--------------|
| Warranty and Service Policy | 3 |
| Safety Instructions..... Cover, 4-6, 9, 15-17, 20-21, 23, 25-29, 31-32, 34, 36 | |
| Materials of Construction | 7 |
| Accessories | 8 |
| Flow Rate Outputs | 9 |
| Modes of Operation | 10 |
| Control Panel Guide..... | 11-12 |
| Pre-Programming Requirements | 13-14 |
| Programming | 15-19 |
| Installation..... | 20-28 |
| Troubleshooting | 29-31 |
| Tube Replacement | 33-35 |
| Cleaning the Point of Injection..... | 36-38 |
| Exploded View..... | 39 |
| Parts | 40 |
| Mounting Template | 41 |

IMEI 122023

WARRANTY AND CUSTOMER SERVICE

LIMITED WARRANTY

Stenner Pump Company will for a period of one (1) year from the date of purchase (proof of purchase required) repair or replace, at our option, all defective parts. Stenner is not responsible for any removal or installation costs. Pump tube assemblies and rubber components are considered perishable and are not covered in this warranty. Pump tube will be replaced each time a pump is in for service, unless otherwise specified. The cost of the pump tube replacement will be the responsibility of the customer. Stenner will incur shipping costs for warranty products shipped from our factory in Jacksonville, Florida. Any tampering with major components, chemical damage, faulty wiring, weather conditions, water damage, power surges, or products not used with reasonable care and maintained in accordance with the instructions will void the warranty. Stenner limits its liability solely to the cost of the original product. We make no other warranty expressed or implied.

RETURNS

Stenner offers a 30-day return policy on factory direct purchases. Except as otherwise provided, no merchandise will be accepted for return after 30 days from purchase. To return merchandise at any time, call Stenner at 800.683.2378 for a Return Merchandise Authorization (RMA) number. A 15% re-stocking fee will be applied. Include a copy of your invoice or packing slip with your return.

DAMAGED OR LOST SHIPMENTS

Check your order immediately upon arrival. All damage must be noted on the delivery receipt. Call Stenner Customer Service at 800.683.2378 for all shortages and damages within seven (7) days of receipt.

SERVICE & REPAIRS

Before returning a pump for warranty or repair, remove chemical from pump tube by running water through the tube, and then run the pump dry. Following expiration of the warranty period, Stenner Pump Company will clean and overhaul any Stenner metering pump for a minimum labor charge plus necessary replacement parts and shipping. All metering pumps received for overhaul will be restored to their original condition. The customer will be charged for missing parts unless specific instructions are given. To return merchandise for repair, call Stenner at 800.683.2378 or 904.641.1666 for a Return Merchandise Authorization (RMA) number.

DISCLAIMER

The information contained in this manual is not intended for specific application purposes. Stenner Pump Company reserves the right to make changes to prices, products, and specifications at any time without prior notice.

TRADEMARKS

Santoprene® is a registered trademark of Celanese International Corporation.



50 West Stoever Ave. • Myerstown, PA 17067
1-800-845-3374 • www.farmerboyag.com

IMPORTANT SAFETY INSTRUCTIONS

When installing and using this electrical equipment, basic safety precautions should always be followed, including the following:

1. READ AND FOLLOW ALL INSTRUCTIONS.

2. WARNING -To reduce the risk of injury, do not permit children to use this product unless they are closely supervised at all times.

3. WARNING -VAC Models only - Risk of Electric Shock. Connect only to a branch circuit protected by a ground-fault circuit interrupter (GFCI). Contact a qualified electrician if you cannot verify that the receptacle is protected by a GFCI.

4. WARNING -VAC Models only -To reduce the risk of electric shock, replace damaged cord immediately.

5. SAVE THESE INSTRUCTIONS.

SAFETY INFORMATION



⚠ WARNING Warns about hazards that CAN cause death, serious personal injury, or property damage if ignored.



ELECTRIC SHOCK HAZARD

VAC MODELS ONLY



⚠ WARNING **ELECTRIC SHOCK HAZARD**

Pump supplied with grounding power cord and attached plug. To reduce risk of electrical shock, connect only to a properly grounded, grounding type receptacle. Install only on a circuit protected by a Ground-Fault Circuit-Interrupter (GFCI). For locations other than US and Canada, pump must be supplied through a residual current device (RCD) with a rated residual operating current < 30mA.



⚠ AVERTISSEMENT **DANGER DE CHOC ÉLECTRIQUE**

La pompe est dotée d'un cordon d'alimentation avec mise à la terre muni d'une fiche. Pour réduire le risque de choc électrique, branchez uniquement sur une prise correctement mise à la terre. Installez uniquement sur un circuit protégé par un disjoncteur différentiel. En dehors des États-Unis et du Canada, la pompe doit être alimentée par un dispositif à courant différentiel résiduel (RCD) fonctionnant à < 30mA.



DO NOT alter the power cord or plug end.



DO NOT use receptacle adapters.



DO NOT use pump with a damaged or altered power cord or plug end. Contact the factory or an authorized service facility for repair.



⚠ WARNING **HAZARDOUS VOLTAGE**

DISCONNECT power cord before removing motor cover for service. **Electrical service by trained personnel only.**



⚠ WARNING **EXPLOSION HAZARD**

This pump is not explosion proof. **DO NOT** install or operate in an explosive environment.



⚠ WARNING **RISK OF EXPOSURE**

Potential for burns, fire, explosion, personal injury, or property damage. To reduce risk of exposure, the use of proper personal protective equipment is mandatory.



⚠ WARNING **RISK OF FIRE HAZARD**

DO NOT install or operate on any flammable surface.



⚠ WARNING **RISK OF CHEMICAL OVERDOSE**

To reduce risk, follow proper installation methods and recommendations. Check your local codes for additional guidelines.



⚠ WARNING To reduce the risk of injury, do not permit children to use this product. This appliance is not to be used by persons with reduced physical, sensory or mental capabilities, or lack of experience and knowledge, unless they have been given supervision or instruction.



⚠ WARNING **RISK OF ELECTRIC SHOCK**

This pump has not been investigated for use in swimming pool or marine areas.



⚠ AVERTISSEMENT **RISQUE DE CHOC ELECTRIQUE**

La pompe n'a pas été vérifiée et approuvée pour utilisation sur des applications de piscine ou autre installation marine.

SAFETY INFORMATION continued

 **CAUTION** Warns about hazards that **WILL** or **CAN** cause minor personal injury or property damage if ignored.

 **CAUTION PLUMBING:**
Metering pump installation must always adhere to your local plumbing codes and requirements. Be sure installation does not constitute a cross connection. Check local plumbing codes for guidelines.

 **CAUTION** This pump has been evaluated for use with water only.

 **NOTICE: Indicates special instructions or general mandatory action.**

 This metering pump is portable and designed to be removable from the plumbing system without damage to the connections.

 Before installing or servicing the pump, read the pump manual for all safety information and complete instructions. The pump is designed for installation and service by properly trained personnel.

 Installation and product must adhere to all regulatory and compliance codes applicable to the area.

 **This is the safety alert symbol. When displayed in this manual or on the equipment, look for one of the following signal words alerting you to the potential for personal injury or property damage.**

 Acceptable for indoor or outdoor use.

 Pour utilisation à l'intérieur uniquement.

 Electrical installation should adhere to all national and local codes. Consult a licensed professional for assistance with proper electrical installation.

 Removing power from recirculation pump must also remove power from pump.

 The use of an auxiliary safety device (not supplied), such as a flow switch or sensor, is recommended to prevent feed pump operation in the event of a recirculation pump failure or if flow is not sensed.

 Point of injection should be beyond all pumps, filters, and heaters.

 Maximum temperature = 40°C

MATERIALS OF CONSTRUCTION

All Housings

Polycarbonate

Pump Tube & Check Valve Duckbill

Santoprene® (FDA approved)

Suction/Discharge Tubing & Ferrules

Polyethylene (FDA approved)

Suction Line Strainer and Cap

PVC or Polypropylene (both NSF listed); ceramic weight

Tube & Injection Fittings

PVC or Polypropylene (both NSF listed)

Connecting Nuts

PVC or Polypropylene (both NSF listed)

All Fasteners

Stainless steel

ACCESSORIES

Contents

3 Connecting Nuts 1/4"

3 Ferrules 1/4"

1 Duckbill Check Valve

1 Weighted Suction Line Strainer 1/4"

20' Suction/Discharge Tubing 1/4", white or UV black

1 Additional Pump Tube

1 Manual

FLOW RATE OUTPUTS

GALLONS & OUNCES

| Pump Prefix | Pump Tube | Roller Assembly | Turndown Ratio | Gallons per Day | Gallons per Hour | Ounces per Hour | Ounces per Minute | Pressure Max. psi |
|-------------|-----------|-----------------|----------------|-----------------|------------------|-----------------|-------------------|-------------------|
| E10RLM | M | White | 10:1 | 0.49 | 0.02 | 2.6 | 0.04 | 80 |
| E10RHM | M | White | 10:1 | 0.83 | 0.03 | 4.4 | 0.07 | 80 |
| E20RHM | M | White | 10:1 | 1.41 | 0.06 | 7.5 | 0.13 | 80 |
| E20RHF | F | White | 10:1 | 4.5 | 0.19 | 24.0 | 0.40 | 80 |
| E20RHG | G | Black | 10:1 | 16.0 | 0.67 | 85.3 | 1.42 | 80 |
| E20RHJ | J | Black | 10:1 | 24.0 | 1.00 | 128.0 | 2.13 | 80 |
| E20RHH | H | Black | 10:1 | 30.0 | 1.25 | 160.0 | 2.67 | 80 |

Approximate Maximum Outputs @ 50/60Hz

LITERS & MILLILITERS

| Pump Prefix | Pump Tube | Roller Assembly | Turndown Ratio | Liters per Day | Liters per Hour | Milliliters per Hour | Milliliters per Minute | Pressure Max. bar |
|-------------|-----------|-----------------|----------------|----------------|-----------------|----------------------|------------------------|-------------------|
| E10RLM | M | White | 10:1 | 1.84 | 0.08 | 76.7 | 1.3 | 5.5 |
| E10RHM | M | White | 10:1 | 3.14 | 0.13 | 130.8 | 2.2 | 5.5 |
| E20RHM | M | White | 10:1 | 5.36 | 0.22 | 223.2 | 3.7 | 5.5 |
| E20RHF | F | White | 10:1 | 17.01 | 0.71 | 708.8 | 11.8 | 5.5 |
| E20RHG | G | Black | 10:1 | 60.48 | 2.52 | 2520.0 | 42.0 | 5.5 |
| E20RHJ | J | Black | 10:1 | 91.00 | 3.79 | 3785.0 | 63.0 | 5.5 |
| E20RHH | H | Black | 10:1 | 113.40 | 4.73 | 4725.0 | 78.8 | 5.5 |

Approximate Maximum Outputs @ 50/60Hz



NOTICE: The information within this chart is solely intended for use as a guide. The output data is an approximation based on pumping water under a controlled testing environment. Many variables can affect the output of the pump. Stenner Pump Company recommends that all metering pumps undergo field calibration by means of analytical testing to confirm their outputs.

MODES OF OPERATION

The Econ Integrator™ is flow activated by a water meter, control valve, flow switch or any equipment that responds to flow. The pump accepts a dry contact or 12-24 VAC/VDC signal and runs at a set time or set speed according to the mode of operation selected.

Before programming, review the pre-programming requirements pages 13 to 14, steps A-D.

SECONDS

In the Seconds mode, the pump receives a dry (non-voltage) contact and runs for a set time in response to receiving the contact. There are five pump operating time ranges and the maximum time is displayed in the control panel; the run time is adjustable from 10% to 100% in 1% increments.

1 SECOND = 0.1 to 1.0

5 SECONDS = 0.5 to 5.0

10 SECONDS = 1.0 to 10.0

20 SECONDS = 2.0 to 20.0

60 SECONDS = 6.0 to 60.0

AUXILIARY

In the Auxiliary mode, the pump receives a 12-24VAC/VDC signal and runs at a set speed for as long as it receives the signal. The pump speed is adjustable from 10% to 100% in 1% increments. If polarity is reversed when connecting a DC signal to the AUX input, the pump will not respond to the signal.

NOTE: The repeater relay does not work with the 12-24 VAC/VDC signal.

FLOW SWITCH

In the Flow Switch mode, the pump receives a dry (non-voltage) contact from a 2 wire flow switch and runs at the set speed for as long as it receives the dry contact. The pump speed is adjustable from 10% to 100% in 1% increments. The connection is not polarity sensitive (polarity is not an issue when connecting the flow switch wires).

The Econ Integrator™ features a repeater relay. The repeater relay provides a **dry contact output signal** that replicates the **dry contact input signal** that the pump receives. This output can be used to control another device that accepts a dry contact signal. The dry contact repeater relay is rated for 36V at 25mA maximum.

CONTROL PANEL GUIDE **BUTTONS**

The control panel has a backlit LCD display; when operating it will display the operating modes and the % setting. The pump is factory pre-set at the lowest settings. The keypad is locked and in standby mode.



To unlock the keypad, simultaneously press and hold **MODE** and **%** for 5 seconds. The keypad will automatically lock if there is no operation for 60 seconds.

Following are the buttons for programming the modes of operation.



To prime the pump or run the pump at full speed, first press & continue to hold **MODE**, then press **PRIME**.



To place the pump in or out of standby, first press & continue to hold **MODE**, then press **STBY**. The pump will not respond to incoming signals when in STBY mode.



To select a mode of operation, first press & continue to hold **MODE**, then press **↑** or **↓** to scroll through the selections. The display will show FLOW SWITCH, AUXILIARY (for 12-24 VAC/VDC), or SECONDS (for water meter).

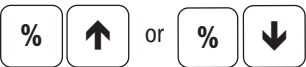

After the operational mode is selected, select the percentage setting. First press & continue to hold **%**, then press **↑** or **↓** until the desired percentage is reached.

CONTROL PANEL GUIDE INDICATORS

The display has flashing indicators beneath the operating mode and setting. The indicators are “PRIME”, “STANDBY”, “SIGNAL” and “KEYPAD LOCKED” and represent the following functions:

PRIME = Prime button is pressed, pump will run full speed

STANDBY = Standby button was pressed, pump is in standby

SIGNAL = Pump received a signal

KEYPAD LOCKED = After 60 seconds of no keypad operation, the keypad will lock and the display will show “KEYPAD LOCKED”

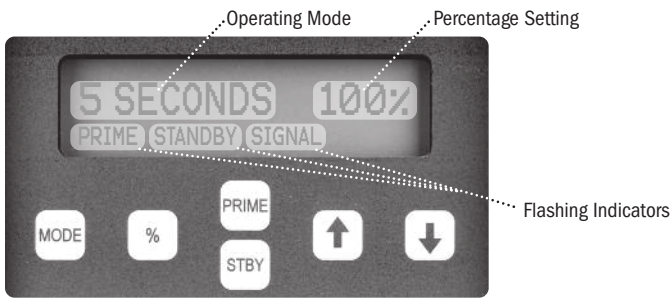

Control Panel

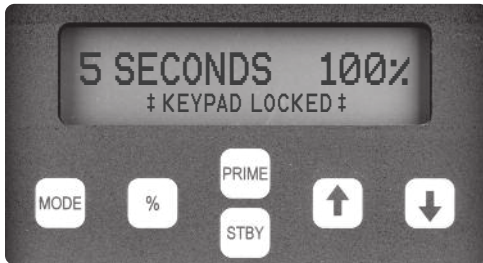

PRE-PROGRAMMING REQUIREMENTS

Before programming the pump, calculate the data in steps A through D then continue with the instructions for the Seconds, Auxiliary or Flow Switch mode.

A. Determine the **Maximum System Flow Rate** or **Well Pump Flow Rate in Gallons per Minute**.

If well pump output is unknown, refer to example below:

Calculate well pump output rate in gallons per minute (gpm).

Determine the output rate by opening a faucet until the well pump turns on. Immediately turn off the faucet and time how long the well pump runs. Next, measure the volume of water drawn from the faucet until the well pump turns on again.

$$\frac{\text{volume of water until the pump turns on (gal.)}}{\text{how long the pump runs (min.)}} = \text{Well Pump Output Rate (gpm)}$$

Example: After drawing 10 gallons of water, the well pump took 2 minutes to fill the pressure tank and stop.

$$\frac{10 \text{ gallons}}{2 \text{ minutes}} = 5 \text{ gpm}$$

B. Determine **Solution Strength Percentage** and the **Dosage Requirement in Parts per Million**.

If dosage is unknown, refer to example below:

Calculate required dosage in parts per million (ppm).

Refer to Oxidation Rates below. Estimate dosage and include the ppm of required residual.

Common Chemical Solution Strengths in ppm

| Name | % | ppm |
|---|-------|---------|
| Sodium Hypochlorite | 5.25 | 52,500 |
| | 6.125 | 61,250 |
| | 12.5 | 125,000 |
| Potassium Permanganate Dissolved at 1/4 lb per gallon | 3 | 30,000 |
| Hydrogen Peroxide | 7 | 70,000 |
| Polyphosphate Dissolved at 1 lb per 10 gallons | 1.2 | 12,000 |

Oxidation Rates

| For each ppm of | Iron | Manganese | Hydrogen Sulfide |
|-----------------------------------|------|-----------|------------------|
| Required ppm of Chlorine | 1 | 2 | 3 |
| Required ppm of Hydrogen Peroxide | 0.5 | 1 | 1.5 |

Example: To treat a water supply containing 2 ppm iron and 4 ppm hydrogen sulfide with a chlorine residual of 1 ppm, a dosage 15 ppm of chlorine is required.

$$2 \text{ ppm iron} \times 1 \text{ ppm chlorine} = 2$$

$$4 \text{ ppm hydrogen sulfide} \times 3 \text{ ppm chlorine} = 12$$

$$1 \text{ ppm chlorine residual} = 1$$

$$\text{Total } 2 + 12 + 1 = 15 \text{ ppm}$$

PRE-PROGRAMMING REQUIREMENTS continued

C. Calculate Metering Pump Output Requirement in Gallons per Day .

$$\frac{\text{Maximum System Flow Rate (gpm)} \times \text{Dosage (ppm)} \times 1440}{\text{Solution Strength ppm}^*} = \text{Metering Pump Output Requirement (gpd)}$$

* Solution Strength % x 10,000 = Solution Strength ppm

D. Reference the chart below to confirm the selected pump's maximum output slightly exceeds the pump output requirement calculated in C.

Econ Integrator™ Pump (up to 80 psi/5.5 bar)

| Pump Prefix | Pump Tube | Roller Assembly | Maximum Output (gpd) |
|-------------|-----------|-----------------|----------------------|
| E1ORLM | M | White | 0.49 |
| E1ORHM | M | White | 0.83 |
| E2ORHM | M | White | 1.41 |
| E2ORHF | F | White | 4.5 |
| E2ORHG | G | Black | 16.0 |
| E2ORHJ | J | Black | 24.0 |
| E2ORHH | H | Black | 30.0 |

SECONDS MODE PROGRAMMING

1. Calculate the **Available Dose Time in Seconds.**

The available dose time is the minimum time interval between the water meter contact closures.

$$\text{a. } \frac{60 \text{ Seconds}}{\text{Maximum System Flow Rate (gpm)}} = \text{Maximum System Flow Rate (spg)}$$

$$\text{b. } \frac{\text{Maximum System Flow Rate (spg)}}{\text{Water Meter's contacts per gallon (cpg)}^*} = \text{Available Dose Time (sec.)}$$

* Refer to the water meter model to confirm the contact rate (cpg).

2. Calculate the **Pump Operating Time in Seconds.**

$$\frac{\text{Pump Output Requirement (gpd)} \times \text{Available Dose Time (sec.)}}{\text{Pump's Maximum Output (gpd)}} = \text{Pump Operating Time (sec.)}$$

 **WARNING** PUMP OPERATING TIME EXCEEDING AVAILABLE DOSE TIME MAY LEAD TO DOSING ERRORS. To reduce operating time, select a pump with a higher output or use a stronger solution strength.

3. Calculate the **Pump Operating Time Percentage.**

Reference the chart to find the pump's maximum operating time for the formula below.

| Seconds Mode | MAXIMUM Pump Operating Time in Seconds |
|--------------|--|
| 1 SECOND | 1.0 |
| 5 SECONDS | 5.0 |
| 10 SECONDS | 10.0 |
| 20 SECONDS | 20.0 |
| 60 SECONDS | 60.0 |

$$\frac{\text{Pump Operating Time (sec.)}}{\text{Maximum Pump Operating Time (sec.)}^{**}} \times 100 = \text{Pump Operating Time Percentage}$$

** Value can only be 1, 5, 10, 20, or 60.

SECONDS MODE continued

PROGRAMMING

4. Program the **Pump Operating Mode** and the **Pump Operating Time Percentage**.

Unlock the Keypad

Press **MODE** and **%** simultaneously and hold for 5 seconds to unlock the keypad.

Pump Operating Mode

First, press and continue to hold **MODE**, then press **↑** or **↓**; when the display shows 1, 5, 10, 20 or 60 SECONDS, release both buttons to select based on the pump operating time determined in #2. The operating mode is now set.

Pump Operating Time Percentage

The pump operating time can be set from 10% to 100% in 1% increments. First, press and continue to hold **%**, then press **↑** or **↓** to adjust the pump operating time percentage determined in #3. When the display shows the desired percent, release both buttons to select. The percentage is now set.

For example, if the pump is set in the 60 seconds mode and the setting is 50%, the pump will run for 30 seconds when it receives a signal from the water meter.

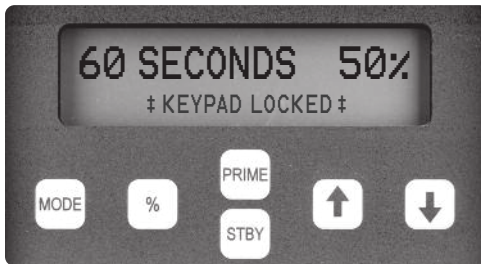

Example of control panel with keypad locked.

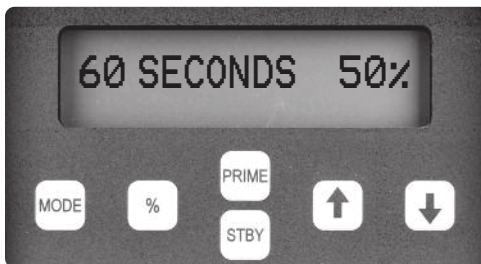

Example of control panel set for 50% of 60 seconds.

AUXILIARY MODE PROGRAMMING

General Guidelines

The pump must interface via a 12-24 VAC/VDC signal from the control equipment.

Refer to the control equipment manual for instructions on how to program the settings and make the signal connections to the metering pump.

1. Program your control equipment:
 - The desired gallons of system water flow (to be treated) per signal
 - The 12-24 VAC/VDC signal duration

NOTE: Smaller water volume between signals generally allows for better uniformity in chemical dispersion.

 **WARNING** IF THE DESIRED SYSTEM FLOW RATE EXCEEDS THE MAXIMUM SYSTEM FLOW RATE, THE AVAILABLE SIGNAL DURATION WILL BE REDUCED AND CAN LEAD TO DOSING ERRORS.

2. Calculate the **Pump Speed Percentage**.

$$\frac{\text{Metering Pump Output Requirement (gpd)} \times 100}{\text{Metering Pump Maximum Output (gpd)}} = \text{Pump Speed Percentage}$$

AUXILIARY MODE continued

PROGRAMMING

3. Select the **Pump Operating Mode** and enter the **Pump Speed Percentage**.

Unlock the Keypad

Press **MODE** and **%** simultaneously and hold for 5 seconds to unlock the keypad.

Pump Operating Mode

First, press and continue to hold **MODE**, then press **↑** or **↓** to scroll through the modes of operation. When the display shows AUXILIARY, release both buttons to select. The operating mode is now set.

Pump Speed Percentage

The pump speed can be programmed from 10% to 100% in 1% increments. First, press and continue to hold **%**, then press **↑** or **↓** to adjust the speed percentage determined in #2. When the display shows the desired percent, release both buttons to select. The percentage is now set.

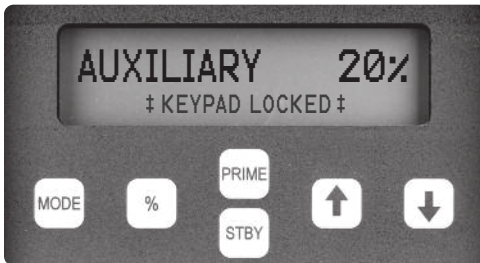

Example of control panel with keypad locked.

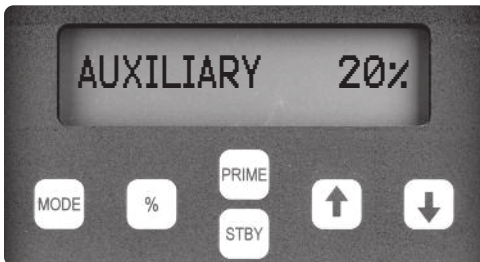

Example of control panel with the pump speed set for 20%.

FLOW SWITCH MODE PROGRAMMING

1. Calculate the **Pump Speed Percentage Setting**.

$$\frac{\text{Metering Pump Output Requirement (gpd)} \times 100}{\text{Metering Pump Maximum Output (gpd)}} = \text{Pump Speed Percentage Setting}$$

2. Program the **Pump Operating Mode** and the **Pump Speed Percentage**.

Unlock the Keypad

Press **MODE** and **%** simultaneously and hold for 5 seconds to unlock the keypad.

Pump Operating Mode

First, press and continue to hold **MODE**, then press **↑** or **↓** to scroll through the modes of operation. When the display shows FLOW SWITCH, release both buttons to select. The operating mode is now set.

Pump Speed Percentage

The pump speed can be programmed from 10% to 100% in 1% increments. First, press and continue to hold **%**, then press **↑** or **↓** to adjust the speed percentage determined in #1. When the display shows the desired percent, release both buttons to select. The percentage is now set.



Example of control panel with keypad locked.

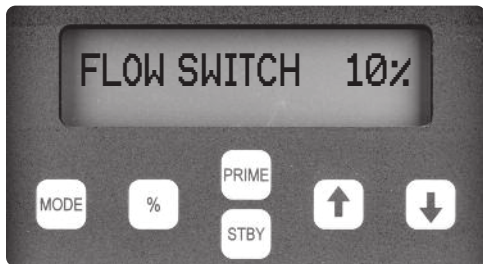

Example of control panel set for 10% in Flow switch mode.

INSTALLATION

ADDITIONAL SAFETY INSTRUCTIONS

! **NOTICE:** Indicates special instructions or general mandatory action.

- !** Read all safety hazards before installing or servicing the pump. The pump is designed for installation and service by properly trained personnel.
- !** Use all required personal protective equipment when working on or near a metering pump.
- !** Install the pump so that it is in compliance with all national and local plumbing and electrical codes.
- !** Use the proper product to treat potable water systems, use only additives listed or approved for use.
- !** Inspect tube frequently for leakage, deterioration, or wear. Schedule a regular pump tube maintenance change to prevent damage to pump and/or spillage.
- !** Pump is not recommended for installation in areas where leakage can cause personal injury or property damage.

24VDC MODELS

POWER INSTRUCTIONS

24VDC Econ models can be controlled by turning on and off the 24VDC power. Electrical installation should adhere to all national and local codes. Consult a licensed professional for assistance with proper electrical installation. The installer is responsible for sizing the equipment used with this pump. Connect power lead wires to a 24VDC power supply.

Red = +24VDC

Black = -24VDC

FUSE INFORMATION

Pump is supplied with a standard 2 amp blade fuse located inside the housing. The fuse holder is taped to the bottom of the housing to keep wires contained when reassembling the pump.

If the fuse fails there is an issue with the pump or power supply.

Identify and correct the issue before changing the fuse.

When changing the fuse be sure to reattach the fuse holder to the tape inside the housing.

INSTALLATION

MOUNT PUMP

- ❗ Select a dry location (to avoid water intrusion and pump damage) above the solution tank.

NOTE: A mounting template is provided on page 41.

- ❗ To prevent pump damage in the event of a pump tube leak, never mount the pump vertically with the pump head up.
- ❗ DO NOT mount pump directly over an open solution tank. Keep tank covered.
- ❗ Avoid flooded suction or pump mounted lower than the solution container. Draw solution from the top of the tank. Pump can run dry without damage. If pump is installed with a flooded suction, a shut-off valve or other device must be provided to stop flow to pump during service.
- ❗ To prevent damage to the pump, verify with a volt meter that the receptacle voltage corresponds with the pump voltage.
- ❗ For outdoor installation, the pump must be mounted vertically to comply with the outdoor rating.

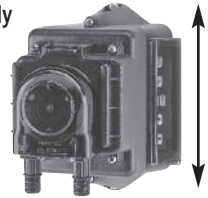

INSTALLATION continued

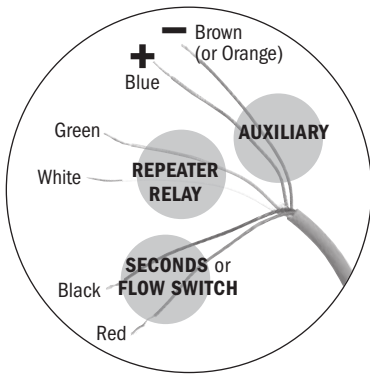

1. Connect signal wires as required by the installation:

SECONDS Black & Red

FLOW SWITCH Black & Red

REPEATER RELAY Green & White

- If using the repeater relay with the Seconds or Flow Switch mode, connect the green & white wires from the pump to the other device.

AUXILIARY Brown (or Orange) & Blue

- For AC signal, there is no polarity.
- For DC signal, blue wire is connected to signal positive (+) and brown (or orange) is connected to signal negative (-).

NOTE: If polarity is reversed when connecting a DC signal to the AUX input, the pump will not respond to the signal.

2. Cap all non-terminated wires.

NOTE: All non-terminated wires must be capped to prevent operational errors or damage to the pump.

3. Plug cord into receptacle. To unlock the keypad, simultaneously press and hold

MODE and **%** for 5 seconds.

4. Put the pump in standby. First, press and continue to hold **MODE**, then press **STBY**.

5. Program the pump for the desired operating mode and % setting, refer to Program Pump Settings in the manual.

NOTE: Leave the unit in standby until the signal wires are connected and the pump is ready for priming.

INSTALLATION continued

ADDITIONAL INSTRUCTIONS FOR CE PUMPS WHEN APPLICABLE

ADDITIONAL INSTALLATION INSTRUCTIONS

1. All Class II Pumps located in Zone 1 of swimming pool areas require locating where flooding cannot occur.
2. This pump is intended to be installed as "fixed" as opposed to portable.
3. The pump must be installed in a vertical position as shown in the installation diagram.
4. After installation, the power supply plug must be accessible during use.
5. This unit must be scrapped if the supply cord is damaged.
6. Observe and comply with all National Wiring Standards.

ZUSTÄZLICHE INSTALLIERUNGSANWEISUNG

1. Pumpen die sich in Zone 1 vom Schwimmbecken befinden sollen sind so einzurichten daß Ueberschwemmungen nicht vorkommen werde.
2. Diese Pumpe ist als fest montierte Ausrüstung bedacht und soll nicht umstellbar gebraucht werden.
3. Die Pumpe muss vertikal installiert werden, siehe Zeichnung.
4. Die Stromversorgung muss nach der Installierung noch zugänglich sein.
5. Bei beschadigter Verkabelung ist dieses Gerat nicht mehr zu gebrauchen.
6. Staatliche Vernetzungsvorchriften müssen eingehalten werden.

INSTRUCTIONS SUPPLÉMENTAIRES D'INSTALLTION

1. Toutes les pompes installées dans la Zone 1 du périmètre de la piscine doivent être situées de manière à ne pas pouvoir être inondées.
2. Cette pompe est prévue pour installation fixe et non pas portative.
3. La pompe doit être installée en position verticale selon le dessin.
4. Après l'installation, la prise électrique doit rester accessible pendant l'utilisation.
5. Cette unité doit être mise au rebut si le cordon électrique est endommagé.
6. Observez et adhérez à toutes les Normes Nationales pour Installations Electriques.

INSTRUCCIONES ADICIONALES PARA INSTALACION

1. Todas las bombas Clase II situadas en la Zona 1 de las áreas de la piscina requieren colocarse donde no puedan ser inundadas.
2. Esta bomba es para ser instalada "fija" en vez de portátil.
3. La bomba debe ser instalada en posición vertical como se muestra en el diagrama de instalación.
4. Depués de la instalación el enchufe suministrador de energía debe estar accesible durante el uso.
5. Se deberá deshechar la unidad si el cordón de abastecimiento se deteriora.
6. Observe y cumpla con todas las Reglas Nacionales para Instalaciones Eléctricas.

ISTRUZIONI SUPPLEMENTARI PER L' INSTALLAZIONE

1. Tutte le pompe Classe II localizzate nella Zona 1 della superficie circostante la piscina devono essere collocate dove gli allagamenti no possono accadere.
2. Questa pompa, é inteso, deve essere installata come 'fissa' e non come portatile.
3. La pompa deve essere installata in posizione verticale come mostrato sul disegno.
4. Dopo l'installazione, la spina deve essere accessibile durante l'uso.
5. Questa unità deve essere gettata via se il filo elettrico é danneggiato.
6. Osservare e aderire a tutte le Norme Nazionali Sugli Impianti Elettrici.

INSTALLATION DIAGRAM

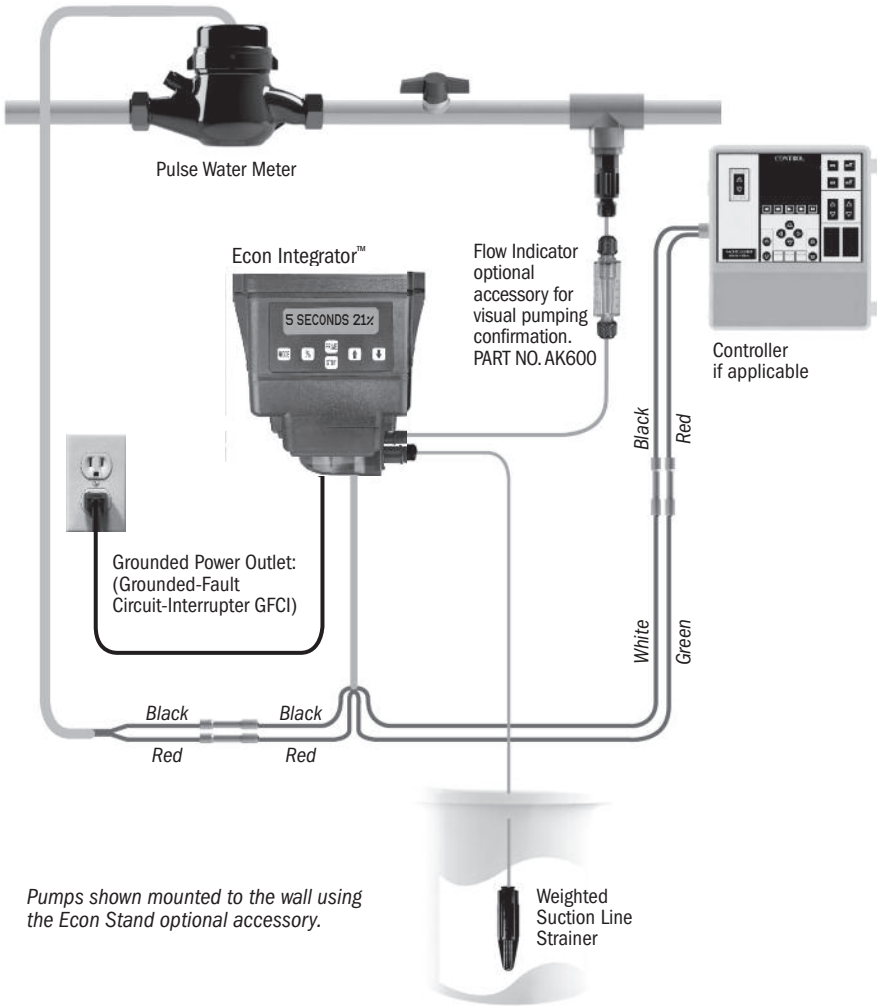

Econ Stand
Part No. EC304



Mounted to wall



Utilized as a stand

INSTALLATION continued

INSTALL SUCTION LINE TO PUMP HEAD

1. Uncoil the suction/discharge line. Use outside of solution tank as a guide to cut proper length of suction line ensuring it will be 2-3" above the bottom of solution tank.
- ❗ **Allow sufficient slack to avoid kinks and stress cracks. Always make a clean square cut to assure that the suction line is burr free. Normal maintenance requires trimming.**
 - ❗ **Suction lines that extend to the bottom of the tank can result in debris pickup leading to clogged injectors and possible tube failure.**
2. Make connections by sliding the line(s) through connecting nut and ferrule and finger tighten to the corresponding tube fittings.
 3. Finger tighten nut to the threaded tube fitting while holding the tube fitting.
- ❗ **Over tightening the nut with a wrench may result in damaged fittings, crushed ferrules, and air pick up.**
 - ❗ **DO NOT use thread sealant tape on pump tube connections or tools to tighten connections.**

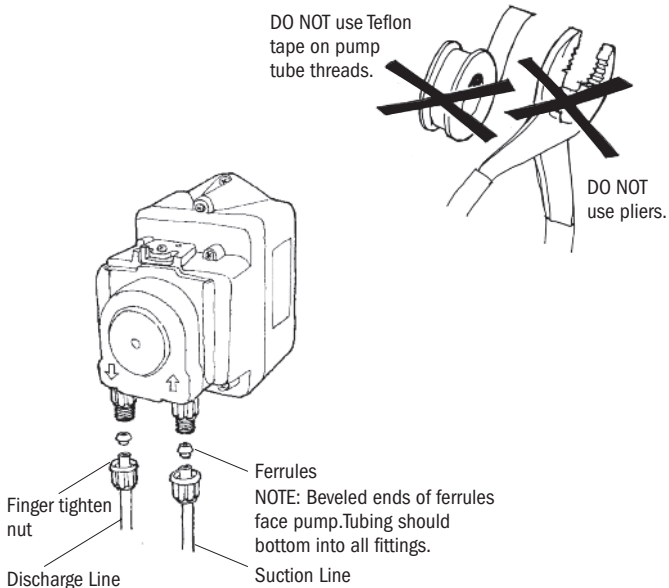

INSTALLATION continued

INSTALL SUCTION WEIGHT TO SUCTION LINE

1. Drill a hole into the bung cap or solution tank lid. Slide the tubing through and secure the weighted strainer to the line.
2. To attach the strainer, push approximately 3.5" of suction line through the cap on the strainer body. Pull tubing to make sure it is secure.
3. Suspend slightly above tank bottom to reduce the chance of sediment pickup.



DO NOT mix additives in the solution container. Follow recommended mixing procedures according to the manufacturer.



DO NOT operate pump unless additive is completely in solution. Turn pump off when replenishing solution.



DO NOT slide tubing all the way to the bottom of the weighted strainer. Tubing could become flush with the nose of the strainer and the pump may not prime due to blockage.

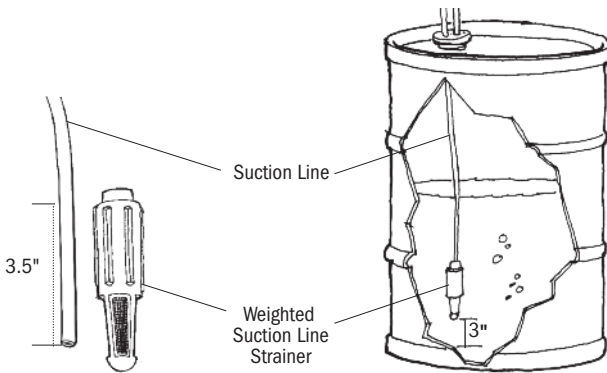

INSTALLATION continued

INSTALL DISCHARGE LINE TO PUMP HEAD AND INJECTION POINT

1. Make a secure finger tight connection on the discharge fitting of the pump head as instructed in Install Suction Line instructions.
- ❗ **DO NOT use thread sealant tape on pump tube connections or tools to tighten connections.**
- ⚠️ **WARNING** **HAZARDOUS PRESSURE: Shut off water or circulation system and bleed off any system pressure.**
- ❗ **Locate a point of injection beyond all pumps and filters or as determined by the application.**
2. A 1/4" or 1/2" Female NPT (FNPT) connection is required for installing the injection fitting. If there is no FNPT fitting available, provide one by either tapping the pipe or installing FNPT pipe tee fitting.
3. Wrap the Male NPT (MNPT) end of injection fitting with 2 or 3 turns of threading tape. If necessary, trim the injection fitting quill as required to inject product directly into flow of water.
4. Hand tighten the injection fitting into the FNPT fitting.
 - a. Install connecting nut and ferrule to the pump discharge tubing. Insert discharge tubing into injection fitting until it reaches base of fitting.
 - b. Finger tighten connecting nut to fitting.

DO NOT use Teflon tape on pump tube threads.

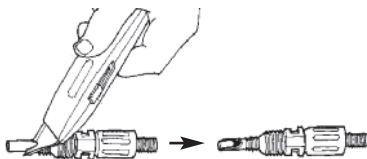
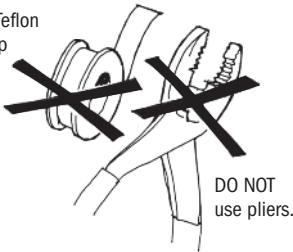

Trim injection fitting end

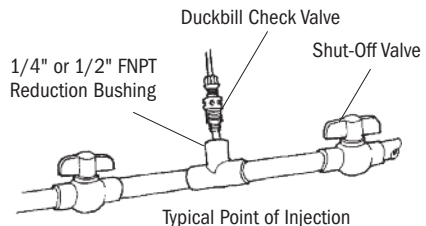

INSTALLATION continued

START PUMP

1. To unlock the keypad, simultaneously press and hold **MODE** and **%** for 5 seconds.
2. Take the pump out of standby. First, press and continue to hold **MODE**, then press **STBY**. Prime the pump. First, press and continue to hold **MODE**, then press **PRIME**. Once the pump is primed, release both buttons. Observe flow as actuated by the system and check all connections for leaks.
3. After suitable amount of dosing time, perform tests for desired readings (e.g., pH or ppm). If necessary, fine tune dosing levels by adjusting the percentage or by adjusting the solution strength.

NOTE: If the signal indicator flashes during the run cycle in the 1, 5, 10, 20, or 60 seconds modes, the meter contacting rate is too high for the setting programmed. Revisit the dry contact water meter programming section and correct the setting to avoid incorrect dosing.

! **NOTICE: The injection point and fitting require periodic maintenance to clean any deposits or buildup. To allow quick access to the point of injection, Stenner recommends the installation of shut-off valves.**

TROUBLESHOOTING DRIVE ASSEMBLY



WARNING

HAZARDOUS VOLTAGE:

DISCONNECT power before service. **Electrical service should be performed by trained personnel only.**

| PROBLEM | POSSIBLE CAUSE | SOLUTION |
|--|--|--|
| Loud or excessive noise | Insufficient gear lubrication Worn gears or gear posts | Apply AquaShield to gears and gear posts Inspect/replace gears and gear posts |
| Drive assembly does not work | Faulty electrical supply Damaged DC motor Damaged power cord | Check electrical supply Replace drive assembly Replace drive assembly |
| Drive assembly runs; output shaft does not turn | Worn or damaged gears Damaged circuit board | Replace gears as needed Replace drive assembly |
| Phenolic gear is stripping | Worn gear posts Rusted helical gear Insufficient lubrication | Replace gear posts & affected gears Buff off helical gear and replace phenolic gear Apply AquaShield to gears and gear posts |

TROUBLESHOOTING PUMP HEAD

| PROBLEM | POSSIBLE CAUSE | SOLUTION |
|--|--|--|
| Components are cracking | Chemical attack Chemical intrusion from tube failure | Check chemical compatibility Identify and correct cause. Clean components of chemical and replace tube according to manual |
| Pump head leaking | Pump tube rupture | Identify and correct cause. Clean components of chemical and replace tube and ferrules according to manual |
| No pump output; pump head rotates | Depleted solution tank or weighted strainer is above solution Leak in the suction line or at connections Ferrules installed incorrectly, missing or damaged Injection point is clogged Clogged suction and/or discharge line and/or check valve Life of pump tube is exhausted Suction tubing is flush with the nose of the weighted strainer Pump cover not secured properly | Replenish solution and position suction line 3" above bottom of tank Correct or replace suction line, and/or connections Replace ferrules, beveled end faces pump Inspect and clean injection point Clean and/or replace as needed Replace tube and ferrules according to manual and schedule tube replacement based on application Pull suction tubing approximately 1" from bottom of strainer; cut bottom of suction tubing at an angle Ensure that pump cover latch is fully closed |
| Low pump output; pump head rotates | Life of pump tube exhausted Rollers worn or broken Injection point is restricted Incorrect tube size or setting High system back pressure Incorrect programming Incorrect wiring Pump cover not secured properly | Replace tube and ferrules according to manual and schedule tube replacement based on application Replace roller assembly Inspect and clean injection point regularly Refer to flow rate output chart and determine correct setting or replace tube with correct size Confirm system pressure does not exceed 80 psi (5.5 bar) maximum Review sizing and programming Check to ensure wiring is correct Ensure that pump cover latch is fully closed |
| No pump output; pump head doesn't rotate | Stripped roller assembly hub Faulty board Drive assembly problem Incorrect programming Incorrect wiring | Replace roller assembly Replace drive assembly Refer to drive assembly troubleshooting Review sizing and programming Check to ensure wiring is correct |
| Pump output is high | Incorrect tube size or setting Roller assembly is broken Incorrect programming Incorrect wiring | Refer to flow rate output chart and determine correct setting or replace tube with correct size Replace roller assembly Review sizing and programming Check to ensure wiring is correct |







TROUBLESHOOTING PUMP TUBE

! **NOTICE:** A leaking pump tube damages the metering pump. Inspect pump frequently for leakage and wear. Refer to Tube Replacement section for additional safety precautions and instructions.

| PROBLEM | POSSIBLE CAUSE | SOLUTION |
|---------------------------------------|---|---|
| Tube leaking | Pump tube ruptured | Identify and correct cause. Clean components of chemical and replace tube and ferrules according to manual. |
| | Mineral deposits at injection point | Clean injection fitting. Replace pump tube, ferrules and duckbill according manual. |
| | Excessive back pressure 80 psi (5.5 bar) maximum | Verify system pressure against tube psi, replace tube and ferrules |
| | Tube is twisted | Replace tube & ferrules according to manual, hold tube fitting while tightening connecting nut to prevent twisting. |
| | Tube not centered | Clean components of chemical, replace tube and ferrules according to manual & confirm tube is centered |
| Tube life is shortened | Chemical attack | Check chemical compatibility |
| | Mineral deposits at injection point | Clean injection fitting. Replace tube, ferrules & duckbill according to manual |
| | Sediment blockage at injection fitting | Clean injection fitting, ensure suction line is 3" above tank bottom; use suction line strainer |
| | Seized rollers caused abrasion on tube | Clean roller assembly or replace, do not lubricate |
| | Exposure to heat or sun | Do not store tubes in high temperatures or in direct sunlight |
| Tube connection is leaking or damaged | Ferrules installed incorrectly, missing or damaged | Replace ferrule, beveled end faces pump; Tube should bottom into tube fitting |

TUBE REPLACEMENT



WARNING RISK OF EXPOSURE

-  To reduce risk of exposure, check the pump tube regularly for leakage. At the first sign of leakage, replace the pump tube.
-  To reduce risk of exposure, the use of proper personal protective equipment is mandatory when working on or near metering pumps.
-  To reduce risk of exposure, and also prior to service, shipping, or storage, pump generous amounts of water or a compatible buffer solution to rinse pump.
-  Consult SDS sheet for additional information and precautions for the additive in use.
-  Personnel should be skilled and trained in the proper safety and handling of the additive in use.
-  Inspect tube frequently for leakage, deterioration, or wear. Schedule a regular pump tube maintenance change to prevent damage to pump and/or spillage.





CAUTION PINCH POINT HAZARD:

-  Use extreme caution when replacing pump tube. Be careful of your fingers and **DO NOT** place fingers near rollers.

WARNING HAZARDOUS PRESSURE EXPOSURE:

-  Use caution and bleed off all resident system pressure prior to attempting service or installation.
-  Use caution when disconnecting discharge tubing from pump. Discharge may be under pressure. Tubing may contain fluid being metered.

NOTICE: Indicates special instructions or general mandatory action.

-  **DO NOT** apply grease, oil, or lubricants to the pump tube or housing.
-  Prior to pump tube replacement, inspect the entire pump head for cracks or damaged components. Ensure rollers turn freely.
-  Rinse off fluid residual and clean all fluid and debris from pump head components prior to tube replacement.
-  **DO NOT** pull excessively on pump tube. Avoid kinks or damage during tube installation.
-  Inspect the suction/discharge tubing, injection point (into pipe), and injection fitting for blockages after any tube rupture. Clear or replace as required.

TUBE REPLACEMENT continued

PREPARATION

1. Follow all safety precautions prior to tube replacement.
2. Prior to service, pump water or a compatible buffer solution through the pump and suction and discharge lines to remove fluid and avoid contact.
3. Disconnect the suction and discharge connections from pump head.

TUBE REPLACEMENT continued

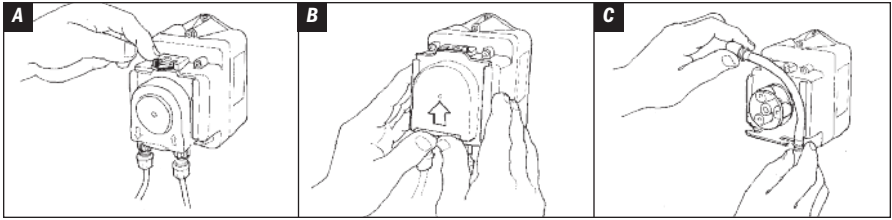

REMOVE TUBE

! Always unplug pump before doing maintenance work.

1. To unlock the keypad, simultaneously press and hold **MODE** and **%** for 5 seconds. REMINDER: The keypad will automatically lock if there is no operation for 60 seconds. Place pump in standby by pressing and continuing to hold **MODE**, then press **STBY**.
2. Unplug the pump.
3. Remove the Phillips head locking screw on the latch (CE models only). Slide the vertical tab 180 degrees from left to right to unlock the cover latch. *Illustration A*
4. To slide cover off, push up on the raised edge. *Illustration B*
5. Release the fittings from the slots to remove the tube. *Illustration C*
6. Remove roller assembly.
7. Use non-citrus all-purpose cleaner to clean residue from pump head housing, roller, and cover.
8. Check cover for cracks. Replace if cracked.
9. Ensure rollers spin freely.
10. Replace roller assembly if: seized, excessive side play from bore wear, or if rollers are visibly worn.
11. Re-install roller assembly.

TUBE REPLACEMENT continued

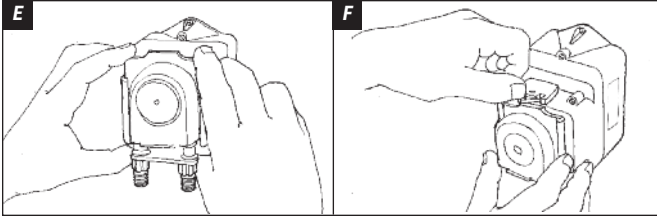
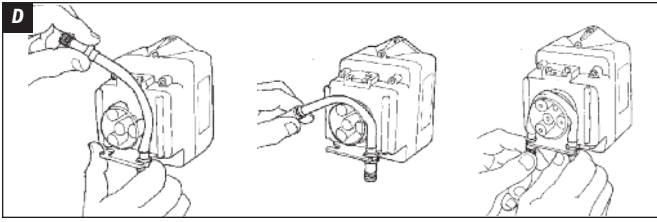

INSTALL NEW TUBE

1. To install new tube, insert one fitting into slot, pull tube around the center of the roller assembly and insert second fitting into the other slot. *Illustration D*
2. Align tube housing cover with track and slide over tube until fully closed. *Illustration E*
3. Plug the pump in.
4. Run the pump to relax the tube. First, press and continue to hold **MODE**, then press **PRIME**, hold both buttons for one minute.
5. To lock cover in place, press down on the cover while turning the vertical tab 180 degrees from right to left. Install the Phillips head locking screw (CE models only). *Illustration F*
6. Take the pump out of standby. First, press and continue to hold **MODE**, then press **STBY**. Run the pump for one minute to verify operation. First, press and continue to hold **MODE**, then press **PRIME**, hold both buttons for one minute.
7. Put pump in standby. First, press and continue to hold **MODE**, then press **STBY**. Reconnect the suction and discharge lines.
8. Prime pump. First, press and continue to hold **MODE**, then press **PRIME**.
9. Place pump in desired operating mode. First, press and continue to hold **MODE**, then press **↑** or **↓**, release both buttons to select operating mode.

CLEANING THE POINT OF INJECTION

ADDITIONAL SAFETY INSTRUCTIONS

NOTICE: Indicates special instructions or general mandatory action.

The duckbill check valve allows the extension tip to be installed in the center of the pipe directly in the flow of water to help reduce deposit accumulation.

WARNING Warns about hazards that CAN cause death, serious personal injury, or property damage if ignored.

This is the safety alert symbol. When displayed in this manual or on the equipment, look for one of the following signal words alerting you to the potential for personal injury or property damage.

WARNING HAZARDOUS PRESSURE/CHEMICAL EXPOSURE

Use caution and bleed off all resident system pressure prior to attempting service or installation.

Use caution when disconnecting discharge line from pump. Discharge line may be under pressure. Discharge line may contain chemical.

To reduce risk of exposure, the use of proper personal protective equipment is mandatory when working on or near chemical metering pumps.

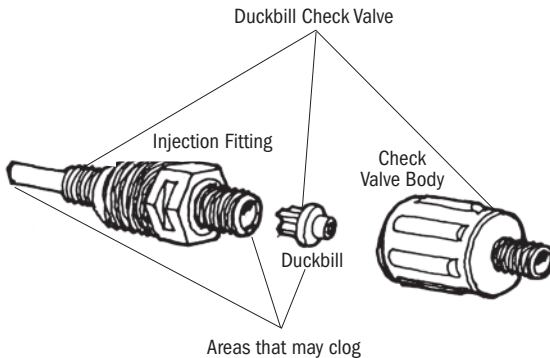

CLEANING THE POINT OF INJECTION continued

1. Turn metering pump off and unplug cord. Disable water pump or auxiliary equipment electrical supply.
2. Depressurize system and bleed pressure from pump discharge line.
3. Loosen and remove connecting nut and ferrule from the duckbill check valve to disconnect discharge tubing.
 - Unscrew the top fitting (check valve body) to disassemble. The bottom fitting (injection fitting with arrow) should remain attached to the pipe.
 - Remove duckbill from check valve body and replace if deteriorated or swollen (replace duckbill with every tube change). If clogged, clean or replace (yearly replacement recommended).
 - Examine O-ring in the injection fitting and replace if deteriorated or damaged.
4. Insert a #2 Phillips head screwdriver through injection fitting into the pipe to locate or break up accumulated deposits. If screwdriver cannot be inserted, drill the deposit out of the injection fitting (DO NOT drill through the opposite pipe wall.)

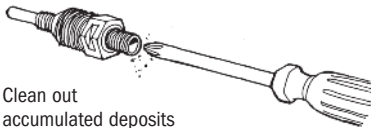
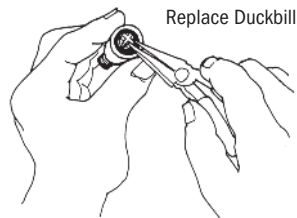

Clean out accumulated deposits with a #2 Phillips head screwdriver.

Periodic inspection and cleaning of the point of injection will maintain proper pump operation and provide maximum tube life.

CLEANING THE POINT OF INJECTION continued

5. Replace discharge line if cracked or deteriorated. If the end is clogged, cut off the calcified or blocked section of discharge line.
 - Reassemble the duckbill check valve.
 - Replace ferrule and reinstall the discharge line to the injection fitting approximately 3/4" until it stops.
6. Tighten the connection nut finger tight.
7. Enable the water pump electrical supply and pressurize the water system.
8. Put the metering pump back in service and inspect all connections for leaks.

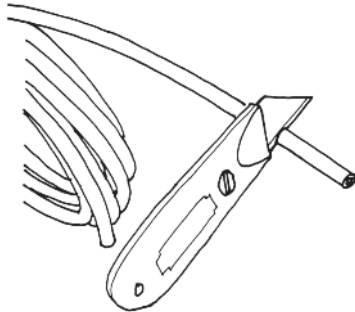

Cut off the calcified or blocked section.

EXPLODED VIEW

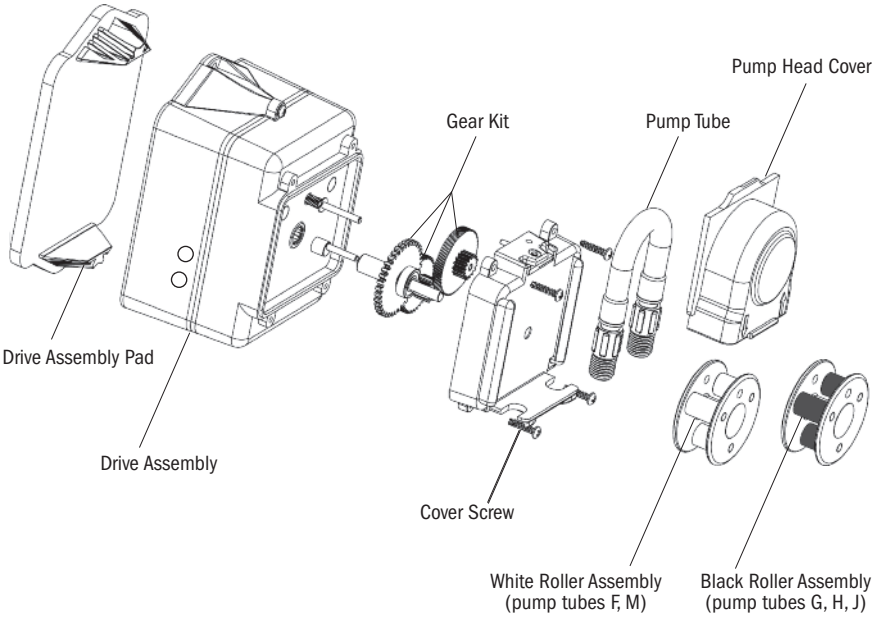

PARTS

Pump Tubes

Includes tube, ferrules 1/4"

| DESCRIPTION | UM | Insert tube # for <input type="checkbox"/> PART NUMBER |
|----------------------------------|------|---|
| F, G, H, J or M Santoprene® tube | 2-PK | EC30 <input type="checkbox"/> -2 |

Pump Head Parts

| DESCRIPTION | UM | PART NUMBER |
|---|----|-------------|
| Roller Assembly, white <i>Tubes F & M</i> | EA | EC350 |
| Roller Assembly, black <i>Tubes G, H & J</i> | EA | EC351 |
| Pump Head Cover | EA | EC355 |

Motor Parts

| DESCRIPTION | UM | PART NUMBER |
|---|-----|-------------|
| Gear Kit with spacers, screws & AquaShield <i>E10 prefix pumps</i> | KIT | EC310 |
| Gear Kit with spacers, screws & AquaShield <i>E20 prefix pumps</i> | KIT | EC320 |
| Drive Assembly Pad | EA | EC302 |
| Mounting Kit <i>for wall mount or Stenner tank</i> | KIT | EC303 |
| Pump Stand <i>for horizontal display or wall mount</i> | KIT | EC304 |

MOUNTING TEMPLATE

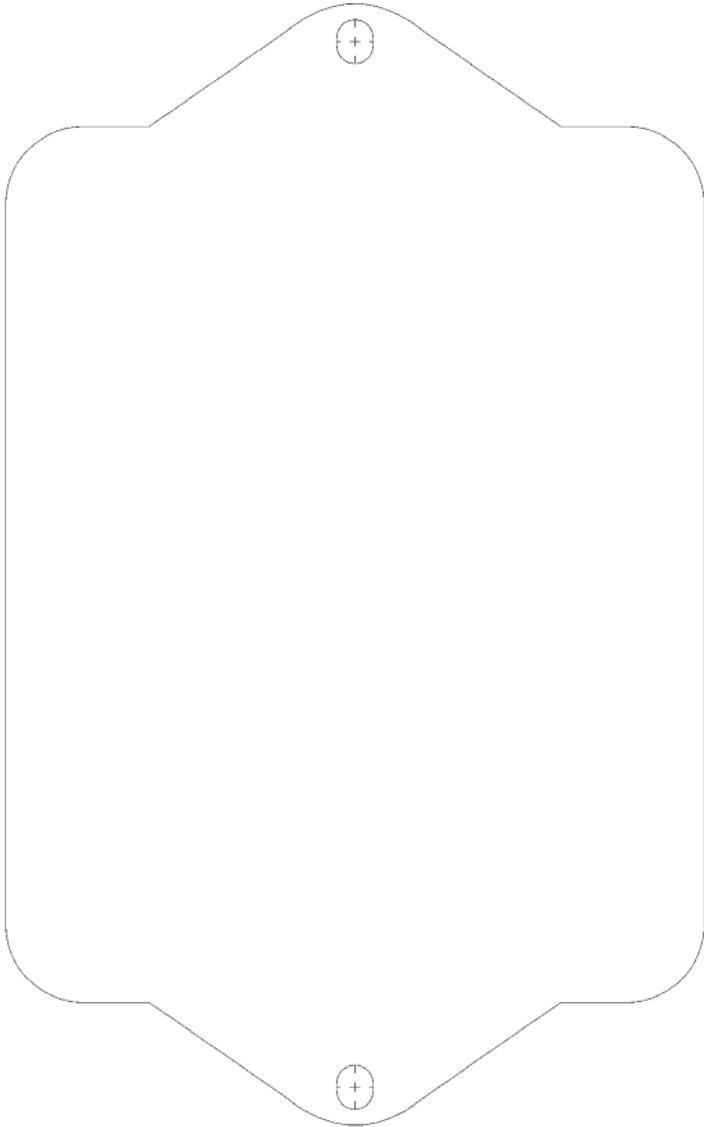



FARMER BOY®

50 West Stoever Ave. • Myerstown, PA 17067

1-800-845-3374 • www.farmerboyag.com

STENNER PUMPS™

STENNER PUMP COMPANY

3174 DeSalvo Road
Jacksonville, Florida 32246 USA

Phone: 904.641.1666

US Toll Free: 800.683.2378

Fax: 904.642.1012

sales@stenner.com

www.stenner.com

Hours (EST)

Mon.-Fri. 7:00 am-8:00 pm

 Assembled in the USA
with US and international components

© Stenner Pump Company
All Rights Reserved